

EER architecture specification for C band OFDM transmitter

A.Diet, C.Berland, M.Villegas, G.Baudoin

ESYCOM – ESIEE (Communications systems laboratory)
2, Boulevard Blaise Pascal, BP99, 93162 Noisy-le-Grand Cedex – France
dieta@esiee.fr, c.berland@esiee.fr, m.villegas@esiee.fr, g.baudoin@esiee.fr

Abstract - This paper presents EER architecture specifications in the case of OFDM C band transmission. The architecture's imperfections such as time mismatch and IQ modulator non-ideality are studied. 16 and 64 QAM modulation each in 32 and 128 sub-carriers case are considered here. EVM results and the spectrum are reported. It predicts the degradation that will occur in the transmitter.

I. Introduction

Band C OFDM modulation is used in wireless local area networks and offers several advantages, like robustness in multi-path environment. However, the signal envelope suffers from large amplitude variation due to the number of sub-carriers ($N\sqrt{2}$ peak to average power ratio). It implies the use of linearization method.

Envelope elimination and restoration [1] is a solution for saving linearity and efficiency at the same time. Nevertheless, performances of that kind of architecture are lowered by imperfections. These defaults have to be taken into account in order to predict the transmitter's performances. This paper presents simulated results allowing precise specifications of the architecture. The simulations are done under HP-ADS Data flow simulator and results are summarised via EVM (Error Vector Magnitude) values and output spectrum.

II. Description of an EER architecture

Principle of EER architecture is illustrated on Fig. 1. The phase signal is digitally generated from the I and Q components of z thanks to a division by the module which is the envelope signal.

$$z = I + j.Q = |z|. \exp^{j.\Phi} = \sqrt{I^2 + Q^2}. \exp^{j.\Phi}$$

These two signals are then up-converted to RF frequency with a quadrature modulator, and amplified. The amplifier is usually a high efficiency one, as the phase signal has a constant envelope property [2].

Re-injection of the envelope information is accomplished by supply modulation. To achieve this restoration, the envelope signal is digitally generated, converted into a PWM signal (Pulse Width Modulation), amplified and low pass filtered. The envelope amplifier is classically a class S one. The resulting signal is used for the polarisation of the high efficiency transmitter PA.

In order to obtain a linear restitution of the envelope, a feedback loop is usually added, including an envelope detector and an adder.

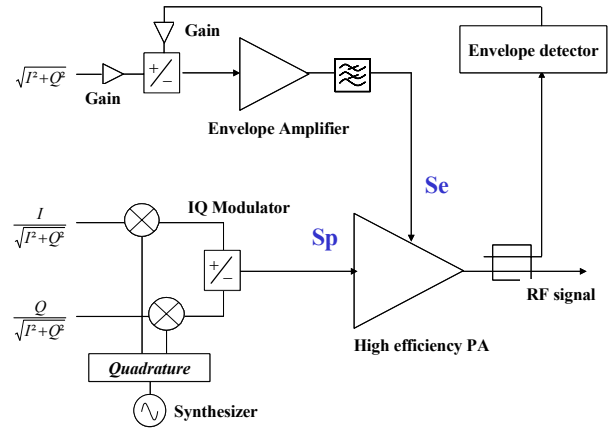

Fig. 1 : EER architecture principle

The imperfections of each block can lower global performances and are discussed in the next section. To simulate their impacts on the studied transmitter, their values were taken at the worst case.

Center frequency is fixed to 5.2 GHz and symbol frequency (F_s) to 20 MHz arbitrarily. Four modulation schemes are considered : 16 and 64 QAM for OFDM modulation with 32 (2^5) and 128 (2^7) sub-carriers.

III. Imperfections sources

There are several sources of imperfections. Filtering of the envelope signal was taken into account in all simulations. Bandwidth limitation is the only filter effect considered. So the simulated filter was a raised cosine one. We chose a corner frequency of $3F_s$ to achieve spectral re-growth lower than -40dBc for frequency offset below $2F_s$ [6] (to fulfil requirement such as 802.11a). A smaller corner frequency would have tightened performances of the other transmitter components.

We first consider the influence of the synthesizer phase noise. OFDM channels are supposed to be spaced from each other by a frequency offset of F_s . The synthesizer, based on a classical single loop architecture, needs a reference frequency value of F_s , and a loop filter with a cut off frequency of $F_s/10$. Actual 5-6 GHz synthesizer performances are: -70 dBc/Hz at $F_s/10^4\text{ Hz}$, -90 dBc/Hz at $F_s/10^3$ until $F_s/10$ (2MHz here, for a 20 MHz reference frequency)

and -20 dB/decade decay from $F_s/10$. Fig 2 presents the phase noise simulation shape.

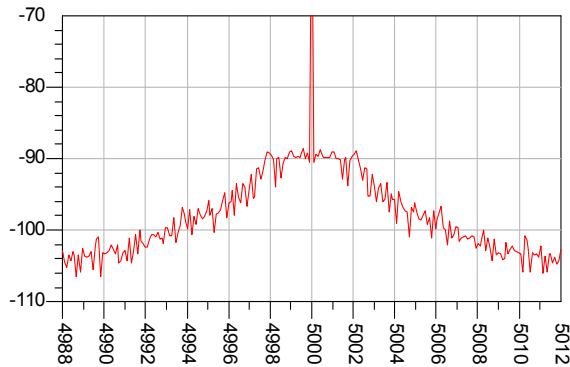

Fig. 2 : Synthesizer phase noise spectrum (dBc/MHz)

The second point taken into account is IQ modulator impairment. Mismatch of phase, DC and AC amplitude between the I and Q signal paths induce image and local oscillator spectral re-growths. Phase shifting and AC amplitude are generated in I/Q path and in LO quadrature generation. For simulation purpose, all of these were gathered into global imperfections on the baseband path. Level of image and LO rejection are linked with DC level, AC and phase mismatch, by demonstrated equations in [2] (ϵ and ϕ represent amplitude and phase error, IRR for Image Rejection Ratio and OLR for Oscillator Rejection) :

$$IRR = 10 \log \left(\frac{1 - 2(1 + \epsilon) \cos(\phi) + (1 + \epsilon)^2}{1 + 2(1 + \epsilon) \cos(\phi) + (1 + \epsilon)^2} \right)$$

$$OLR = 10 \log \left(\frac{4(V_{i_{dc}}^2 + V_{q_{dc}}^2)}{(V_{i_{ac}} + V_{q_{ac}})^2} \right)$$

We choose a -30 dBc rejection for OL and -26 dBc for the image, still for a worst case analysis. This is equivalent to gain and phase imbalance of respectively 0.6 dB and 5° .

The next imperfections concern the restoration block. Encountered problems are difficult to model, due to PA non-linear response. The technology, class and topology of the PA have to be carefully studied to choose the appropriate one [3]. The envelope signal modulates the PA voltage supply, but VDD variation causes amplitude compression and phase conversion, different from classical AM/AM and AM/PM effects. In OFDM case, these effects are worsened by the fact that the dynamic is proportional to the number of sub-carriers N [4][6]. As an example the peak to average power ratio (PAPR) is 16.55 dB for $N=32$ and 22.57 dB for $N=128$. Such levels of PAPR underline the dynamic problem and so the non-linear response in the envelope recombination. The compression effect (VDD/AM) is simulated using an AM/AM model applied to the envelope signal. The conversion effect (VDD/PM) is simulated using an AM/PM model on the phase signal controlled by the envelope one. Both are represented on Fig. 3

Finally, the last simulated imperfection is time mismatch between envelope and phase paths. Time delay causes EVM, spectrum distortions and rotation

of individual sub-carrier constellation. This rotation is linked to the delay and to the frequency offset from the center carrier. The delay also generates inter-symbol interference [7]. This delay is set to 5% of the symbol time. This value is not high because time mismatch is highly destructive on emitted signal quality. An adaptive correction of the envelope phase synchronisation is then necessary. The overall transmitter architecture simulation does not take into account the digital to analog converter limitations.

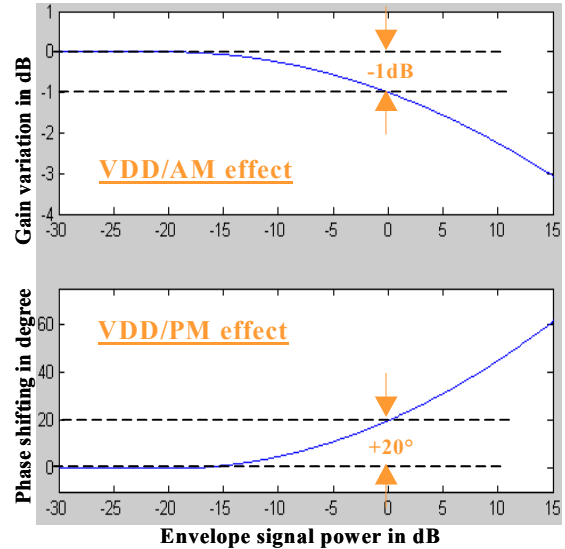

Fig. 3 : VDD/AM and VDD/PM models used

All of these imperfections will degrade both spectral and EVM performances. Results are summarised and imperfections are simulated alone and cumulated in the architecture for the four modulation schemes considered.

IV. Results

Results of EVM from different simulations are reported in Tab. 1 The influence of envelope filtering was discussed in part III and causes 0.4% EVM whatever the modulation scheme is.

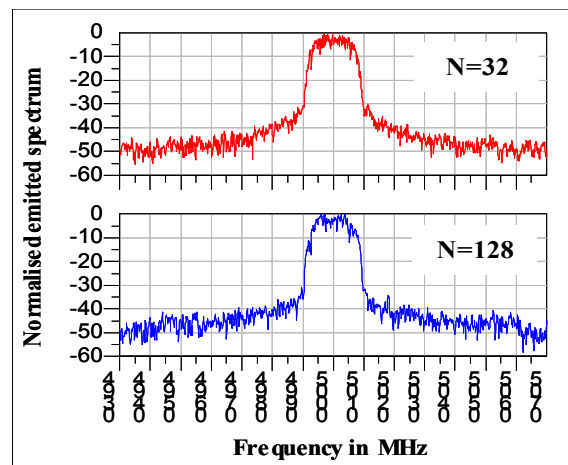

Fig. 4 : Influence of phase noise on 16 QAM spectrum

The first simulation, concerning phase noise influence, highlight EVM increase, between 7 to 8% depending on modulation, with a cluttered

constellation, and a spectrum spreading. EVM increases with the number of sub-carriers, while the bandwidth remain constant. Phase noise is transposed to each sub-carrier, this implies the emitted noise to be the sum of all noise contributions.

The IQ modulator default simulation exhibits a constant EVM value of about 7%, whatever the modulation scheme is. This is due to the fact that real and imaginary part of the OFDM signal behave like Gaussian distributed signals for a large number of sub-carriers (central limit theorem). So, the phase signal is uniformly distributed, as the envelope follows the Rayleigh law. In the case of EER, only the phase signal is impacted with IQ modulator impairment. As this signal keeps its probability density constant for both numbers of sub-carrier, the effect of these defaults remains the same.

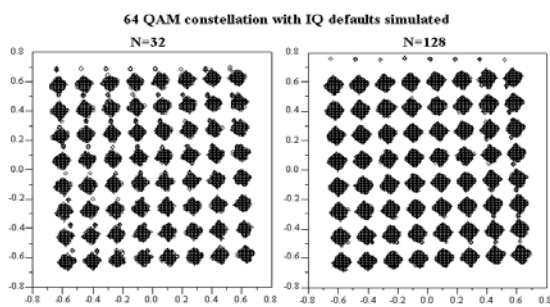

Fig. 5 : 64 QAM constellation with IQ default

EVM evolution for important IQ defaults (IRR=22dBc, OLR=-35dBc) in function of different sub-carriers numbers is plotted on Fig. 6. This one demonstrates that the hypothesis of central limit theorem can be applied for $N > 32$.

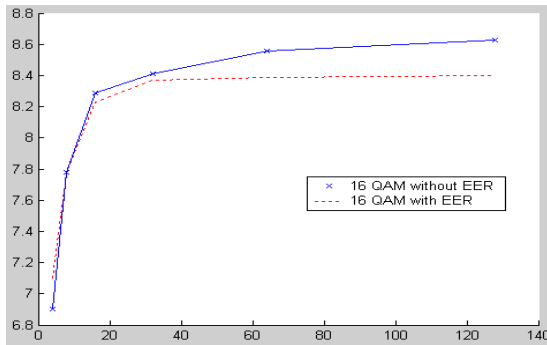

Fig. 6 : Evolution of 16 QAM EVM in function of the number of sub-carriers

When phase noise and IQ modulation default are both taken into account, EVM attains 9.3 to 9.6%.

The next step concerns restoration imperfections. A 4dB back-off (from the reference point marked on Fig. 3) was necessary in simulations corresponding to a linearization. Concerning envelope compression, increasing of EVM can be observed, from 2.7% (N=32) to 3.15% (N=128), with an adjacent channel spectral re-growth. Here is one of the limiting factors for the sub-carriers number in OFDM transmission. The higher N the higher the EVM. Linearization of the envelope signal is highly needed. This underlines the influence of non-linearity recombination on the

quality of the signal and so the need of a feedback loop in order to minimize VDD/AM effect.

The simulation of VDD/PM effect causes a dissymmetrical spectrum. Each sub-carrier is phase modulated, with a spreading of its spectrum. This depends of the probability density of the envelope signal bandwidth (Woodward). Due to different instantaneous signal powers on each sub-carriers, the resultant spectrum is dissymmetrical. EVM increases in function of modulation schemes from 8.6% to 9.8% with the same 4dB “back-off”. This underlines the high penalty of conversion effect.

At last, the delay is added to the imperfection list. The impact of the delay mismatch can be observed on the output spectrum. Spectral re-growths are in the range of -35dBc at F_s (20 MHz) offset from the center frequency, when the delay is 5% of the symbol time.

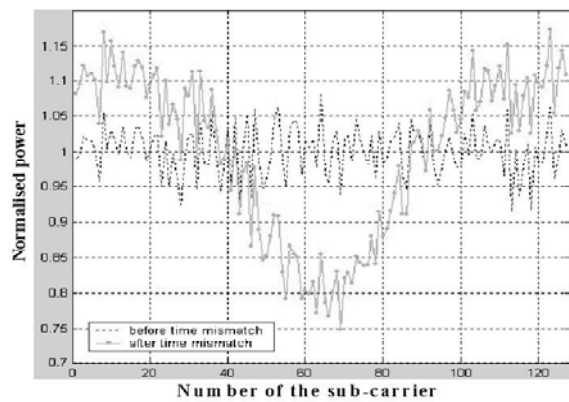

Fig. 7 : Evolution of normalised power on sub-carriers (20%Ts time mismatch) for 64 QAM

With the simulation of time mismatch between phase and envelope, the instant power repartition (calculated on 300 OFDM symbols) on sub-carriers can be observed. It presents a non-uniform repartition (Fig.7), so that the spectrum asymmetry caused by VDD/PM is increased (illustrated by Fig.8).

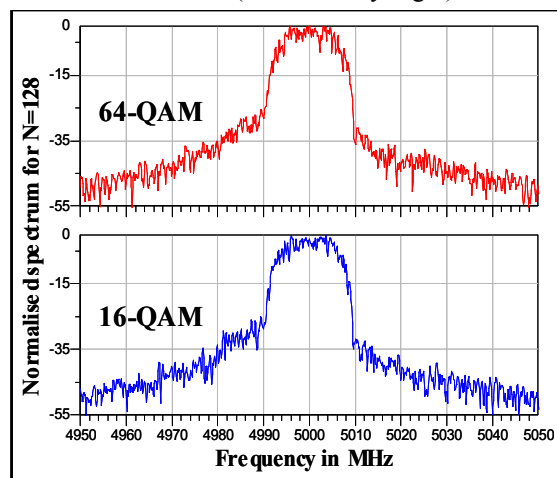

Fig. 8 : Normalised emitted spectrum with VDD/PM effect and time mismatch default for N=128

Final spectrum with all defaults cumulated for the four considered schemes are presented on Fig. 9. Spectral re-growth at 20MHz from the carrier

frequency reach -25dBc for $N=128$, with a 16QAM. According to standard, this may be too important.

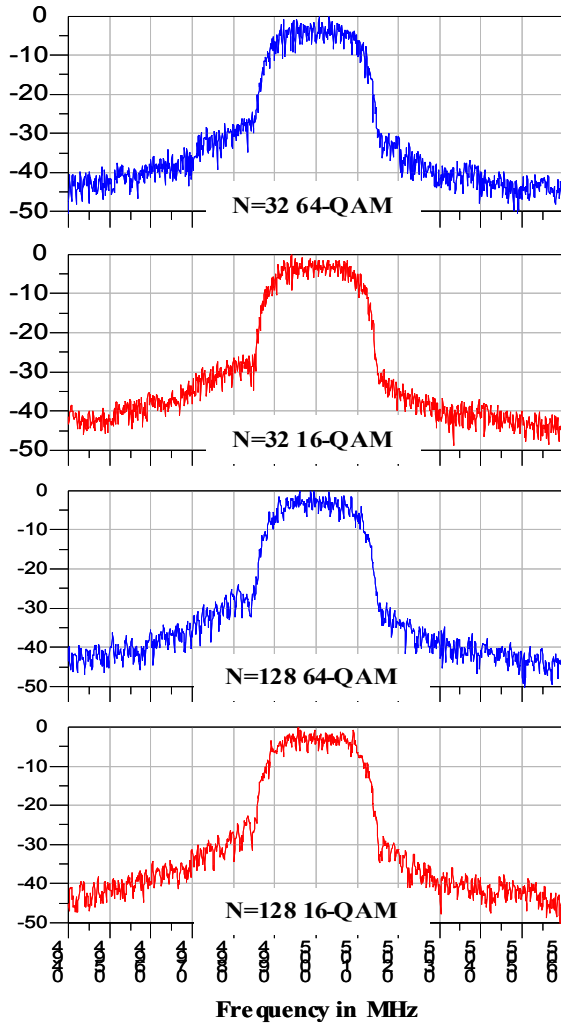

Fig. 9 : Normalised emitted spectrum (all defaults)

The EVM evolution in Tab.1 shows the importance of both phase noise and amplifier imperfections. EVM, in our worst case study, can reach 14%, which is higher than expected values for usual standards, such as 802.11 (11% for example, or less).

Imperfections/modulations	N=32		N=128	
	16QAM	64QAM	16QAM	64QAM
Phase noise	7,27	7,3	7,51	7,55
IRR = -26 dBc	5,54	5,55	5,55	5,55
OLR = -30 dBc	2,2	2,2	2,2	2,2
IRR+OLR	6	6	6,02	6,03
Phase noise + IRR + OLR	9,27	9,3	9,57	9,6
VDD/AM (4 dB BO)	2,71	2,82	3,1	3,15
VDD/PM (4 dB BO)	8,6	8,9	9,71	9,8
VDD/AM + VDD/PM	8,93	9,33	10,12	10,2
Phase noise + IRR + OLR + VDD/AM + VDD/PM	13,02	13,47	14,1	14,15
Time mismatch = 5%Ts	2,55	2,55	2,49	2,5
Time mismatch + VDD/PM	8,9	9,26	9,9	10
Phase noise + IRR + OLR + VDD/AM + VDD/PM + Time mismatch	13,24	13,65	14,3	14,35

Tab. 1 : EVM Results in % rms

To refine transmitter's performances, complementary simulations have to be done. The phase noise profile is taken 5dB below the previous one, decreasing EVM value to 4%. IRR of -40dBc and OLR of -36dBc are achieved with modulator adjustment. The VDD/PM effect is also reduced by a half. These imperfections lead to EVM of about 9.5%. Results are reported on Tab.2. It has to be underlined that VDD/AM and VDD/PM effects are simulated here without any back-off. Spectral regrowths at 20MHz from the carrier frequency decreases to -28dBc ($N=128$ sub-carriers, 16QAM).

Imperfections/modulations	N=32		N=128	
	16QAM	64QAM	16QAM	64QAM
Phase noise (-95dBc)	4,43	4,46	4,5	4,54
Phase noise + IRR (-40dBc) + OLR (-36dBc)	4,64	4,69	4,76	4,81
VDD/PM	6,1	6,3	6,8	6,92
Phase noise + IRR + OLR + VDD/AM + VDD/PM + Time mismatch	9,27	9,5	9,63	9,8

Tab.2 : EVM results after adjustments (%rms).

V. Conclusion

This paper presents architecture simulations of envelope elimination and restoration transmitter. The simulations were worsted in order to identify critical paths and precisely specify blocks' performances. Results of simulations reveal the importance of the signal dynamic on EER architecture. The design of the transmitter amplifier is a key point to lower quality degradation of the emission. Compression and conversion effects can't be avoided but need to be minimised by a correction loop or other linearization techniques. Time delay mismatch is so critical that a synchronisation loop will have to be used : 5% T_s is difficult to achieve with aging and temperature phenomenon. Phase noise of the synthesiser is an other important source of performances degradation that has to be lowered. For example a level of -95dBc at $F_s/100$ causes no more than 4.4% of EVM. Finally, IQ modulator will have to be tuned to cancel AC, DC and phase error. Typical rejection values, -40dBc for the image and -36dBc for the local oscillator, are necessary.

VI. Bibliography

- [1] L.Kahn, *Single sideband transmission by envelope elimination and restoration*, IRE proc., pp 803-806, July 1952.
- [2] G.Baudoin et al. *Radiocommunications numériques n°1, Principes, modélisation et simulation*, Dunod, 2002.
- [3] M.Villegas et al. *Radiocommunications numériques n°2, Conception de circuits intégrés Rf et micro-ondes*, Dunod, 2002.
- [4] W.Liu, J.Lau, R.Cheng, *Consideration on applying OFDM on a PA*. IEEE trans. on circuits and systems II, Nov. 1999.
- [5] B.Cutler, *Effects of physical layer impairments on OFDM systems*. RF design, May 2002.
- [6] A.Diet, C.Berland, M.Villegas, G.Baudoin, *Sensibilité d'une architecture EER à une modulation OFDM dans le système Hiperlan2*, XIIIèmes journées nationales micro-ondes à Lille, 2003.
- [7] G.Baudoin, C.Berland, M.Villegas, A. Diet, *Influence of time and processing mismatches between phase and envelope signals in linearization systems using EER.*, Proc. Conf. IEEE MTT'2003, Philadelphia 2003.