

EFFICIENT IN-PLANE GAP-CLOSING MEMS ELECTROSTATIC VIBRATION ENERGY HARVESTER

R. Guillemet¹, P. Basset¹, D. Galayko², F. Marty¹ and T. Bourouina¹

¹Université Paris-Est, ESYCOM, ESIEE Paris, Noisy-le-Grand, France

²LIP6, UPMC Universités Paris Sorbonne, Paris, France

Abstract: This paper presents the design, fabrication and testing of a fully batch fabricated MEMS electrostatic Vibration Energy Harvester (eVEH) based on a gap-closing comb-drive structure. The electrostatic transducer is made in a 400- μm -thick silicon wafer, whose total capacitance can vary from 40 to 290 pF under external acceleration. The experimental setup adds a parasitic capacitance of 30 pF. Up to 8.8 nJ/cycle where harvested around 250 Hz in a continuous charge-voltage cycle and 6.9 nJ in an improved charge-pump circuit, corresponding to 2.3 μW and 1.8 μW respectively. Finally, we tested our device with the charge-pump over a period of several minutes. After 500 sec, the harvested power is still 938 nW.

Keywords: energy harvesting, vibration, electrostatic transduction, batch process

INTRODUCTION

Vibration Energy Harvesters (VEH) catch mechanical energy through a spring mass system, and then convert the largest part as possible of this energy into electrical power. Electromagnetic, piezoelectric or electrostatic transduction can be used, and sometimes a combination of them. VEH with electrostatic transduction (eVEH) present interesting features which can make the difference with the other types of transduction: they are well suitable for fabrication in silicon-based MEMS technologies through fully batch fabrication process [1][2][3]. Moreover, the bulk crystalline silicon keeps elastic properties even in strong deformation mode [5]. Therefore, it can be used for fabrication of nonlinear springs for wideband VEH [6]. The main drawback is that contrary to electromagnetic and piezoelectric VEH, eVEH need to be pre-charged in order to initiate the conversion process. So, to obtain a totally battery-free system, an electret or a piezoelectric layer need to be added [7].

In a previous work we have presented MEMS eVEH based on an In-Plane Overlap-Plate structure working at 250 Hz. This device had generated around 1 nJ per mechanical oscillation in a continuous mode of operation [8], but only 2.4 pJ in a charge-pump conditioning circuit [9][1] because of its low capacitance variation. One of the main advantages of this transducer geometry is the possibility to obtain a multiplication of the frequency of the transducer capacitance variation with regard to the mechanical vibration frequency factor, and a possibility to deposit an electret layer. On the other hand, it is hard to obtain a small gap between the two electrodes because of the electrostatic instabilities (pull-in and Paschen effects),

which limits the maximum capacitance of the transducer.

Several in-plane overlap comb-drive eVEHs have been presented [2][3]. The main issue with such architecture is the difficulty to obtain a large capacitance variation, so they required several tens of volts for the pre-charge or/and a high frequency of operation to get a significant amount of power.

In this paper, we report the design, fabrication and testing of a fully batch fabricated MEMS electrostatic eVEH based on a gap-closing comb-drive structure which delivers a few μW to a resistive load at frequencies around 250 Hz.

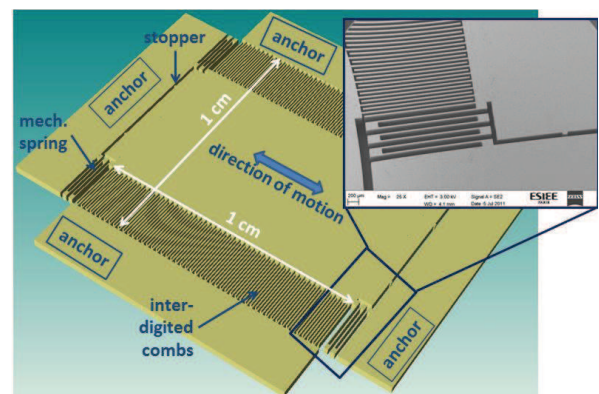

Figure 1. Schematic view of the active part of the e-VEH. Inset: SEM close-up view of the fabricated device.

DESCRIPTION OF THE HARVESTER

The MEMS device

The eVEH is a variable capacitance based on two interdigitated combs having a variable gap between the fingers (cf. fig. 1). The mobile mass is attached to the frame by 4 linear springs, and mechanical stoppers

between the mass and the frame prevent from shorts circuits between the fingers. The total area of the active parts (mass+springs+comb's fingers) is 1.1 cm². The mobile parts are etched by DRIE (Bosh process) in a 380 μm-thick doped silicon wafer using an aluminum mask. The silicon wafer is then anodically bonded on a glass wafer which has been pre-etched by liquid HF below the mobile parts. After the dicing, the MEMS are glued on to a PCB and mounted on a vibrating table, as shown in fig. 2.

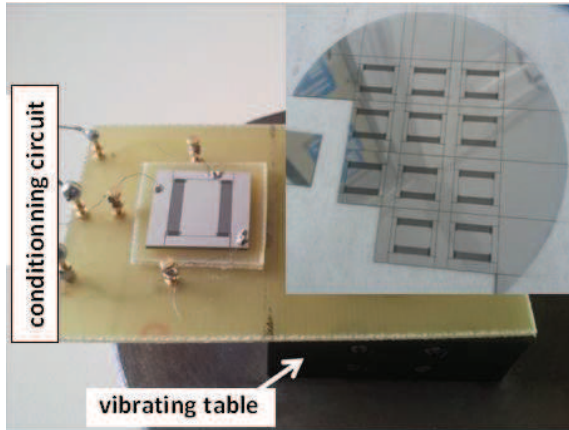

Figure 2. Picture of the eVEH mounted on the vibrating table used for the experiment. *Inset:* wafer with multiple devices just after the dicing.

The conditioning circuits

The role of the conditioning circuit (C.C.) is to implement a cyclic charge-discharge of the capacitive transducer as required for the electromechanical energy conversion [1]. To test the device presented in this article, two C.C. were used. The first one is that implementing a continuous charge-voltage QV cycle. A large reservoir capacitance is used for a pre-charge of the transducer. In absence of leakage, the average energy of the reservoir capacitance remains constant, and the current through the load is due to the variation of the transducer capacitance. Because of the zero leakage requirement, this circuit is not suitable fully autonomous applications. For evaluation, the reservoir capacitance is often replaced with a constant voltage source, so to avoid the issues related with a real capacitor leakage. This was the case in our test experience (fig. 3-a), whose results are presented in the next section.

To provide an additional validation, the fabricated MEMS devices were tested with conditioning circuit based on a charge pump composed of two diodes, one large reservoir capacitor and one intermediate capacitor (proposed by Roundy in [10]). The variations of the transducer capacitance are used to transfer (to pump) the charges from the large C_{res}

capacitor (~1-10 μF) to a smaller C_{store} capacitor (1-10 nF). Since the energy of electrical charges is inversely proportional to the capacitance value, this transfer corresponds to an increase of the electrical energy in the network $C_{res}C_{store}$. This gained energy comes from the mobile mass vibrations.

An exploitation of this gained energy requires a flyback circuit returning the charges from C_{store} to C_{res} . In this paper we used a simple resistive flyback (fig. 3-b): the load resistor connected between C_{res} and C_{store} experience a current, hence, energy. It can be seen that if the load consumes the converted energy, in absence of leakage, the average energy of the capacitive system remains constant.

To compensate the unavoidable charge loss due to the load supply and/or to the capacitor leakage, an alternative and more complex flyback circuit has been proposed by Yen [11] which use an inductive flyback. Several other works presents a study about the design of such conditioning circuit [13][14]; this subject if out of scope of this paper.

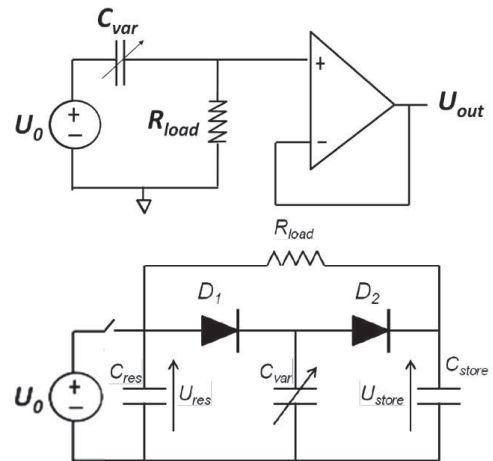

Figure 3. a) Continuous mode Conditioning Circuit. b) Improved charge-pump C.C..

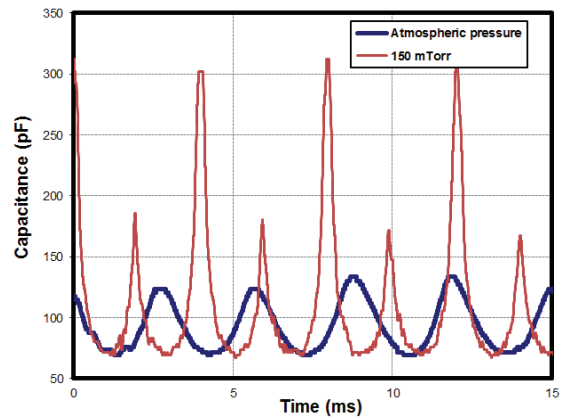

Figure 4. Capacitance measurements of the e-VEH at atmospheric pressure and 150 mTorr

EXPERIMENTAL RESULTS

Dynamic characterization of the capacitance

The measurement of the transducer capacitance C_{var} has been performed by measuring the phase shift in a RC_{var} circuit [1]. Measurement results are shown in fig. 4. At atmospheric pressure, the maximal variable capacitance ratio for 1 g sinusoidal vibrations is $C_{var_max} / C_{var_min} = 130 \text{ pF} / 70 \text{ pF}$ at 162 Hz. When the pressure decreases, a higher displacement of the mobile electrode is obtained due to the reduction of the fluid damping. At 150 mTorr the $C_{var_max} / C_{var_min}$ ratio becomes $320 \text{ pF} / 70 \text{ pF}$ at 250 Hz. This large frequency shift shows that the transducer behavior is highly non-linear with the amplitude of the mobile electrode. It should be noted that the experimental set-up adds a parasitic capacitance of 30 pF to the measured capacitances.

We can also observe in fig. 4 an alternation between 2 maximum values. A similar behavior has also been observed in a mixed VHDL-AMS/ELDO simulation [12] during the energy conversion process using the continuous mode C.C., as shown in fig. 5. When the two electrodes become close enough, the electrostatic force induces an asymmetry in the mass displacement which leads to a period doubling of the capacitance variation. If the displacement continues to increase, the variation of the capacitance will become irregular and the electrostatic pull-in finally occurs. Another explanation of the alternation of the maximum capacitance could be that the mobile electrode hits the stoppers which are not fully elastic.

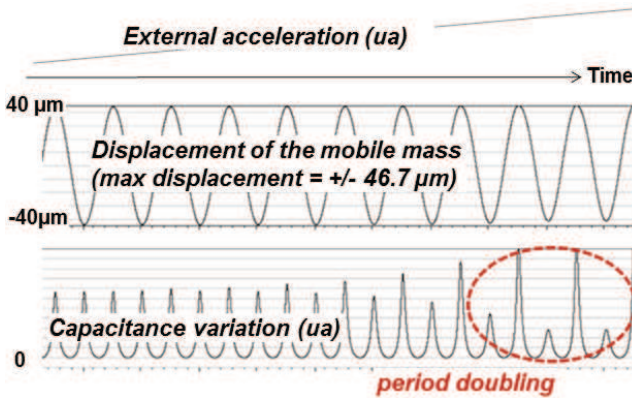

Figure 5. Mixed VHDL-AMS/Spice of an in-plane gap-closing eVEH implemented in a continuous mode C.C. and for a linear ramp of acceleration.

Harvested power with “continuous mode” C.C.

Fig. 6 shows the harvested power with the conditioning circuit in fig. 3-a, for various load resistances and polarization voltages U_0 . The excitation is a 250 Hz sinus of 1 g in amplitude. The

output voltage is highly non harmonic because of the nonlinear variation of the capacitance and is not rectified, so the power dissipated across the loads is calculated as:

$$P_{Rload} = \frac{1}{t_2 - t_1} \int_{t_1}^{t_2} \frac{U_{out}^2}{R_{load}} dt \quad (1)$$

The measurements have been performed at 150 mTorr. The optimum output resistance is between 500 k Ω and 1 M Ω . Up to 2.3 μW have been obtained for a voltage $U_0 = 10 \text{ V}$, which corresponds to $\sim 9 \text{ nJ}$ per mechanical oscillation or $\sim 4.5 \text{ nJ}$ per electrical cycle. For higher U_0 , pull-in instability occurs, leading to short-circuit between fixed and movable electrodes.

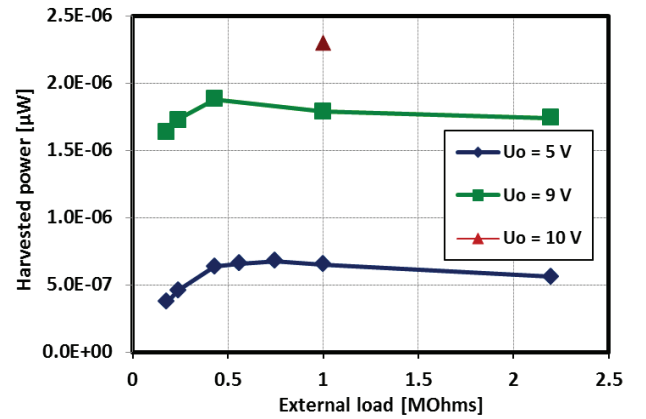

Figure 6. Measurements of the maximum harvested power using the circuit of figure 3-a for different values of pre-charge U_0 .

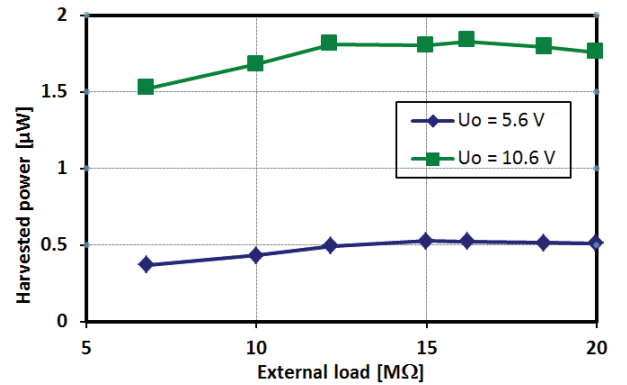

Figure 7. Measurements of the maximum harvested power using the circuit of figure 3-b for 2 values of pre-charge U_0 .

Harvested power with the charge pump C.C.

The measurements of the maximum harvested power using the circuit of figure 3-b are shown in fig. 7. Similar experimental conditions are used, i.e. 150 mTorr and a sinusoidal vibration of 1 g at 250 Hz. In the first experiment, the voltage source is

continuously connected to C_{res} . For $U_o = 10.6$ V (~ 10 V on C_{var}) the maximum harvested power is $1.8 \mu\text{W}$ for a resistive load around $15 \text{ M}\Omega$. This corresponds to ~ 7 nJ per mechanical cycle and is slightly less than when using the continuous mode conditioning circuit.

We also have monitored the harvested power versus time in similar conditions but in autonomous mode. To do so, the system is initially pre-charged at 10.6 V and the voltage source U_o is disconnected from C_{res} . Measurements of voltages across C_{res} and C_{store} are shown in fig. 8. The corresponding harvested power starts with $1.4 \mu\text{W}$ and quickly decreases to $1.1 \mu\text{W}$ after 100 sec of operation. After that, we observe an almost constant decrease of the power with rate of about 20 nW per 50 sec due to capacitance leakages.

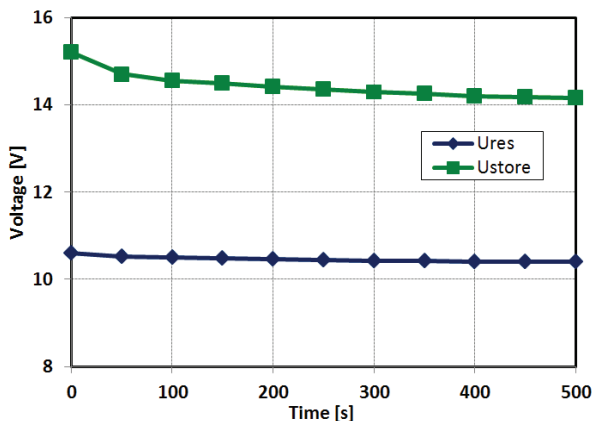

Figure 8. Measurements of U_{res} and U_{store} versus time using the circuit of fig. 3-b on a $15 \text{ M}\Omega$ load. U_o is set to 10.6 V and is disconnected at $t=0$ s.

CONCLUSION

We have presented an in-plane gap-closing and batch-fabricated eVEH, working without electret, able to harvest up to 9 nJ at 250 Hz on a $1 \text{ M}\Omega$ load and with an area of 1.1 cm^2 . The maximum efficiency of the device is limited by the undercut of the comb-finger electrodes during the etching process which drastically decreases the value of the maximum capacitance. In addition, the minimum value of C_{var} is strongly affected by the parasitic capacitance introduced by the experimental setup. The device behavior is highly non-linear with regard to the amplitude of vibrations, even though the springs are supposed to be linear. Further analyses are ongoing.

REFERENCES

[1] P. Basset, D. Galayko, A. M. Paracha, F. Marty, A. Dudka, T. Bourouina, "A Batch-Fabricated and Electret-free Silicon Electrostatic Vibration

Energy Harvester" *JMM*, 19 (2009) 115025

[2] D. Hoffmann, B. Folkmer and Y. Manoli, "Fabrication, characterization and modelling of electrostatic micro-generators", *JMM*, 19 (2009) 094001

[3] D. S. Nguyen, E. Halvorsen, G. U. Jensen and A. Vogl, "Fabrication and characterization of a wideband MEMS energy harvester utilizing nonlinear springs," *JMM*, 20 (2010) 125009

[4] S. Boisseau, G. Despesse and A. Sylvestre, "Optimization of an electret-based energy harvester", 2010 *SMS*, 19 075015

[5] Y. Nada, M. Medhat, M. Nagi, F. Marty, B. Saadany, T. Bourouina, "Mechanical displacement multiplier: $250 \mu\text{m}$ stable travel range MEMS actuator using frictionless simple compliant structures", *MEMS'12*, pp. 1161-64, 2012

[6] M. Amri, P. Basset, F. Cottone, D. Galayko, F. Najar and T. Bourouina, "Novel Nonlinear Spring Design for Wideband Vibration Energy Harvesters", *PowerMEMS'12*, 2012

[7] D. Miki, M. Honzumi, Y. Suzuki and N. Kasagi, "Large-amplitude MEMS electret generator with non-linear spring", *MEMS'10*, pp. 176-79, 2010

[8] P.D. Mitcheson, T. Sterken, C. He, M. Kiziroglou, E. M. Yeatman and R. Puers, "Electrostatic Microgenerators", *Meas. & Control J.*, 41 (4), 114, 2008

[9] A. Mahmood Paracha, P. Basset, D. Galayko, F. Marty, and T. Bourouina, "A silicon MEMS DC/DC converter for autonomous vibration-to-electrical energy scavenger", *EDL*, Vol. 30, no 5, pp. 481-483, 2009

[10] S. J. Roundy, "Energy Scavenging for Wireless Sensor Nodes", *PhD Thesis of University of California-Berkeley*, 2003

[11] B. C. Yen and J. H. Lang, "A variable capacitance vibration to electric energy harvester", *TCAS*, vol. 53, no. 2, pp. 288-95, 2006

[12] D. Galayko, R. Pizarro, P. Basset, and A. Mahmood. Paracha, "AMS modeling of controlled switch for design optimization of capacitive vibration energy harvester", *BMAS'07*, pp. 115-120, San José, USA, 2007

[13] A. Dudka, D. Galayko, P. Basset, "Smart adaptive power management in electrostatic harvesters of vibration energy", *PowerMEMS'09*, 2009

[14] A. Kempitiya, D.A. Borca-Tasciuc and M.M. Hella, "Analysis and optimization of asynchronously controlled electrostatic energy harvesters", *TIE*, vol. 59, no 1, pp. 456-63, 2012